

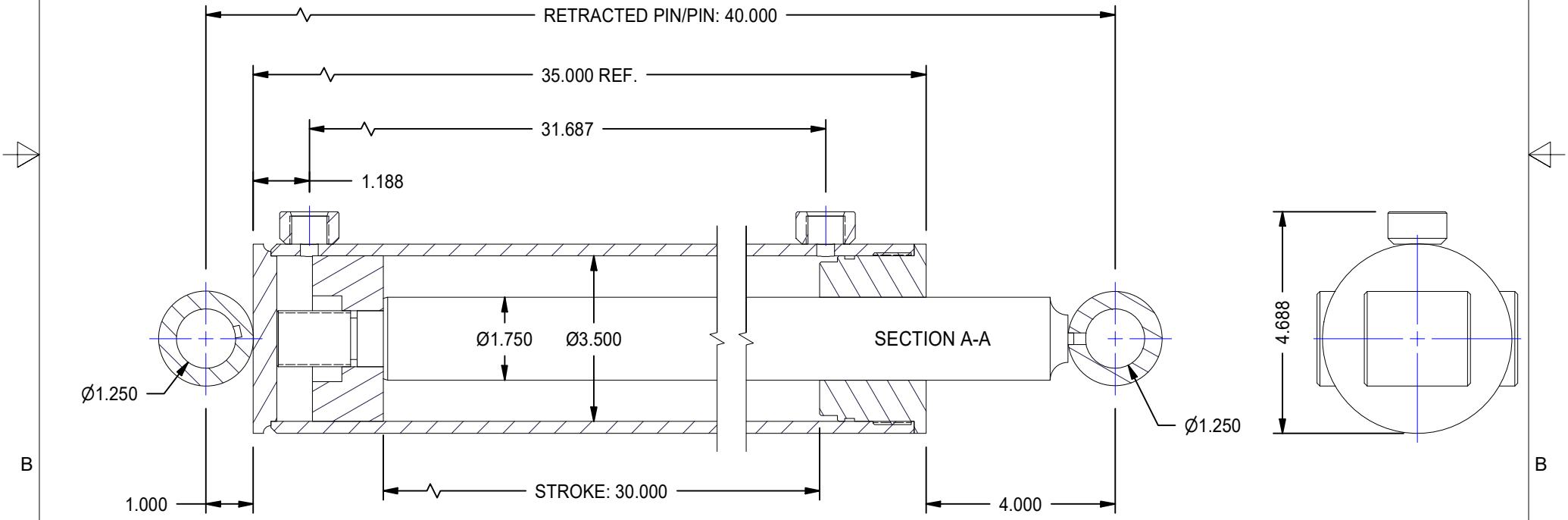

1

2

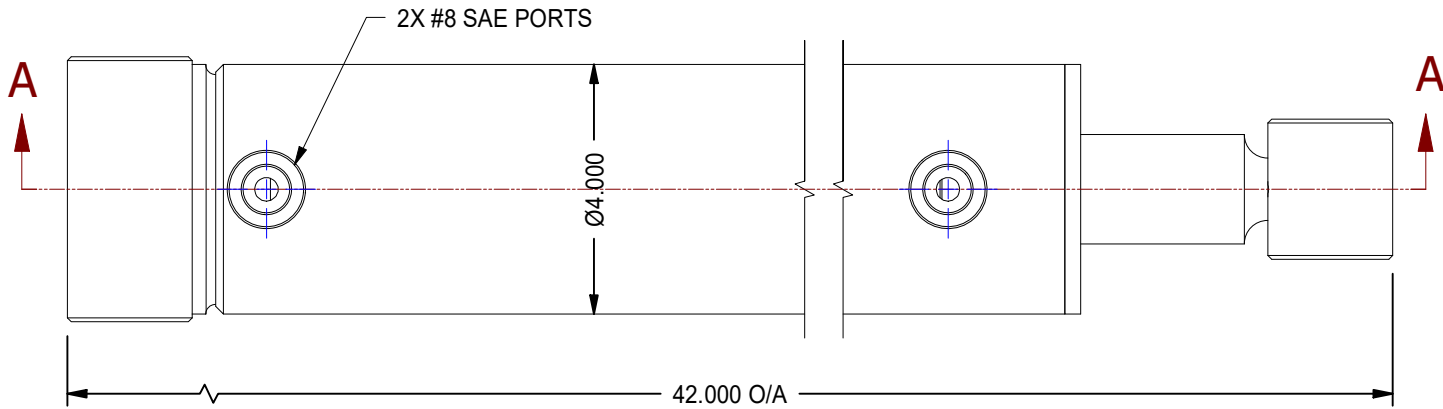

MODEL NUMBER:		PROJECT/CUSTOMER INFO:		DSGND:	DATE: 2010-08-12
 TITAN WORLDWIDE INC. <small>31 ton 3500 L</small> <small>Clear fluid or glycol in case of power. One that stands out for greatness of achievement!</small> <small>PHONE: 807-474-5337 FAX: 807-623-5692 EMAIL: info@titanworldwide.com WEB: www.titanworldwide.com</small>		CAPACITY:		WEIGHT: N/A	
		SHEET: A		SHEET: 11 OF 15	
701 MONTREAL STREET THUNDER BAY, ON P7E 3P-2 CANADA TEL: 807-474-5337 FAX: 807-623-5692 www.titanworldwide.com		TITLE: TTN35TB30		DRAWING No:	
DATE		INTL		DESCRIPTION	
REV					

1

2