

1

2

A

A

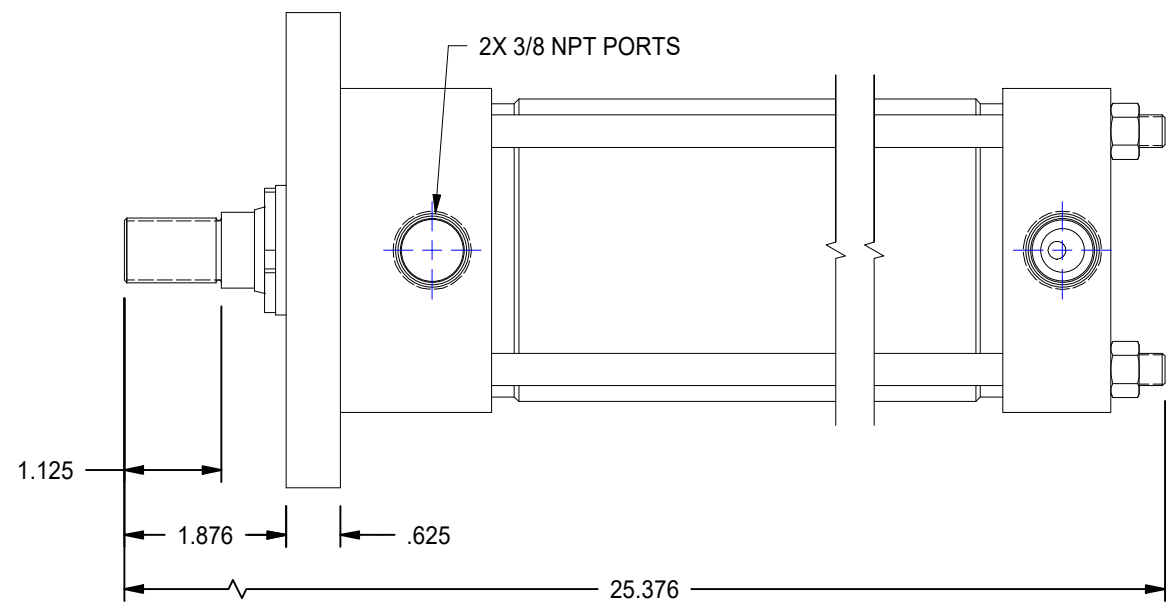

B

B

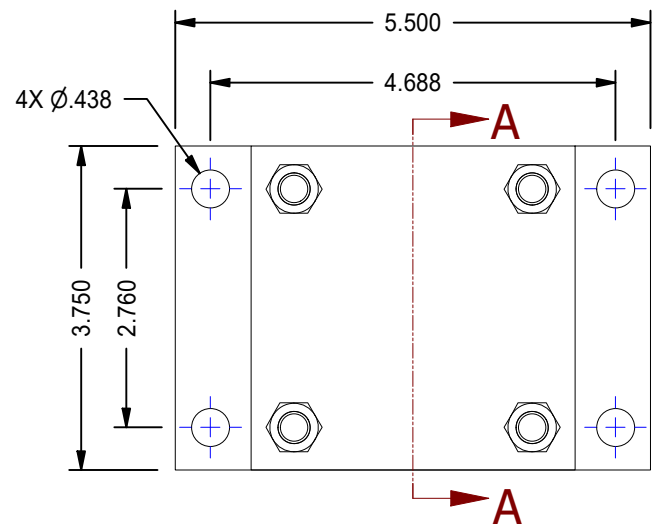
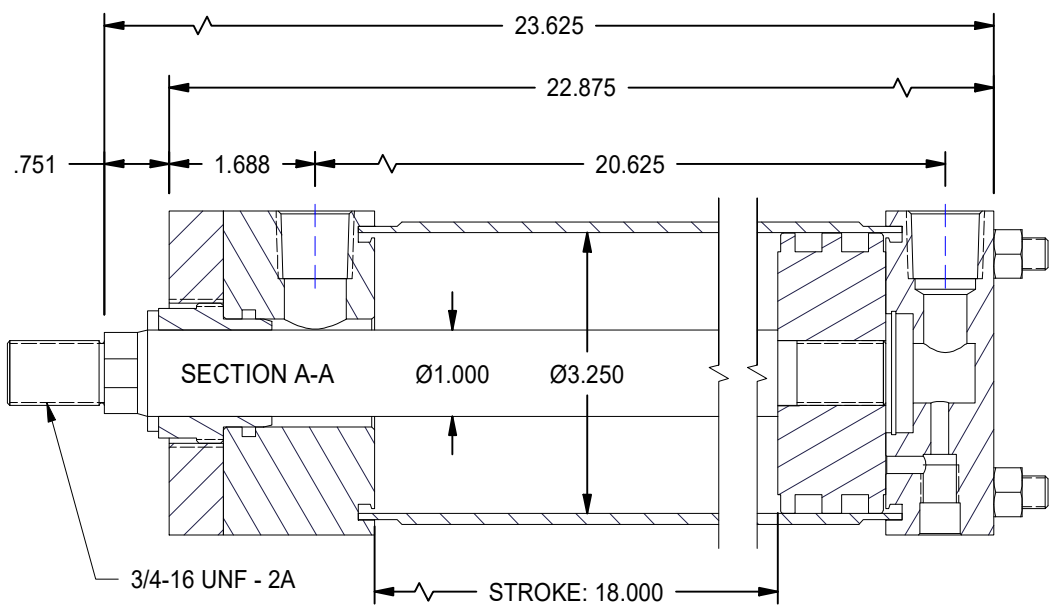

1

2



DATE	INTL	DESCRIPTION	REV

MODEL NUMBER:

PROJECT/CUSTOMER INFO:

DSGND: DATE: 2013-03-07

CAPACITY: 3000 PSI

WEIGHT: 30.597 lbmass

SHEET SIZE: A SHEET: 1 OF 1 FILENAME: TRP3.25MF1LU14X18.00.idw

TITLE: TRP3.25MF1LU14X18.00

DRAWING No: REVISION:

701 MONTREAL STREET  
THUNDER BAY, ON  
P7E 3P-2  
CANADA  
TEL: 807-474-5337  
FAX: 807-623-5692  
www.titanworldwide.com