

1

2

A

A

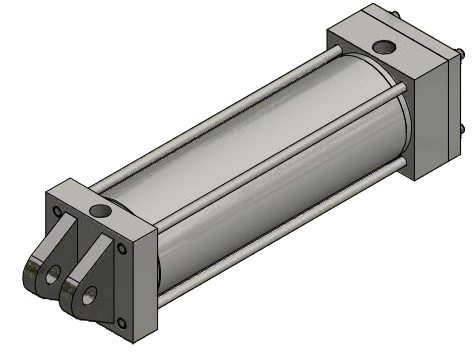
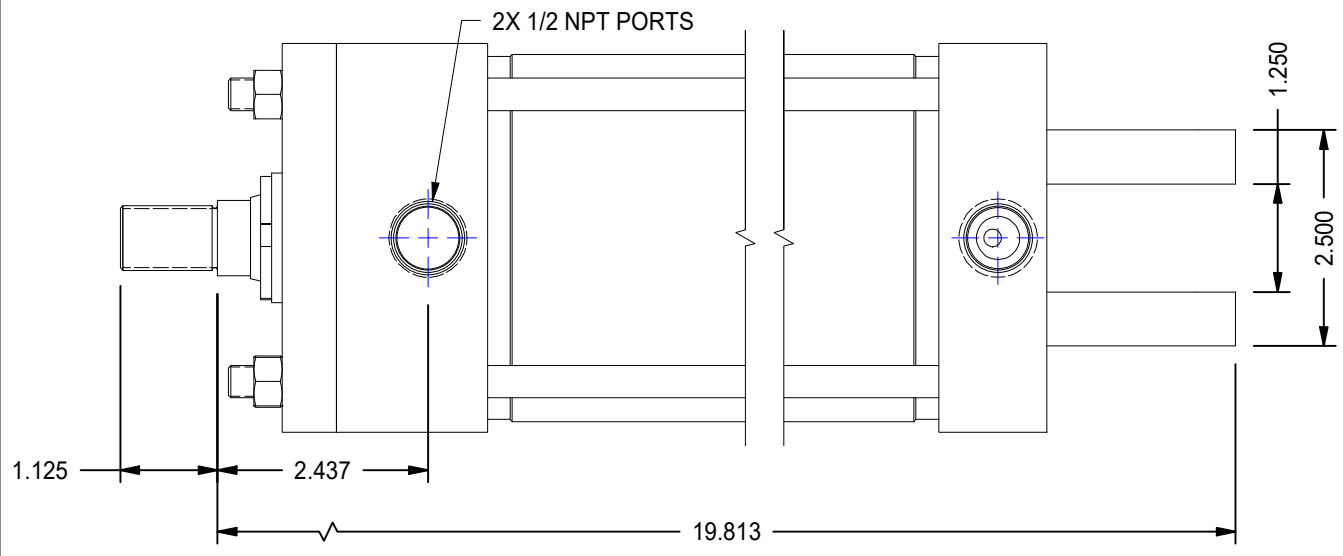

B

B

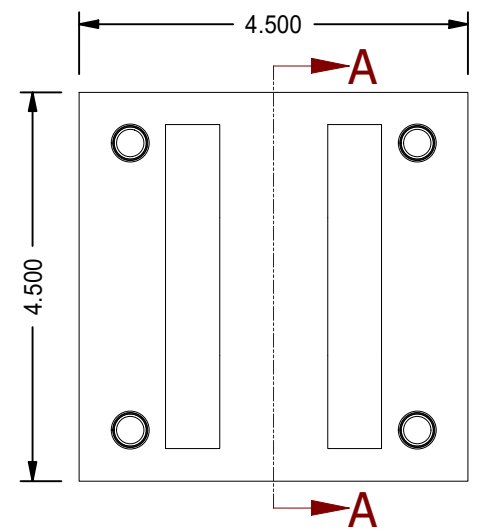
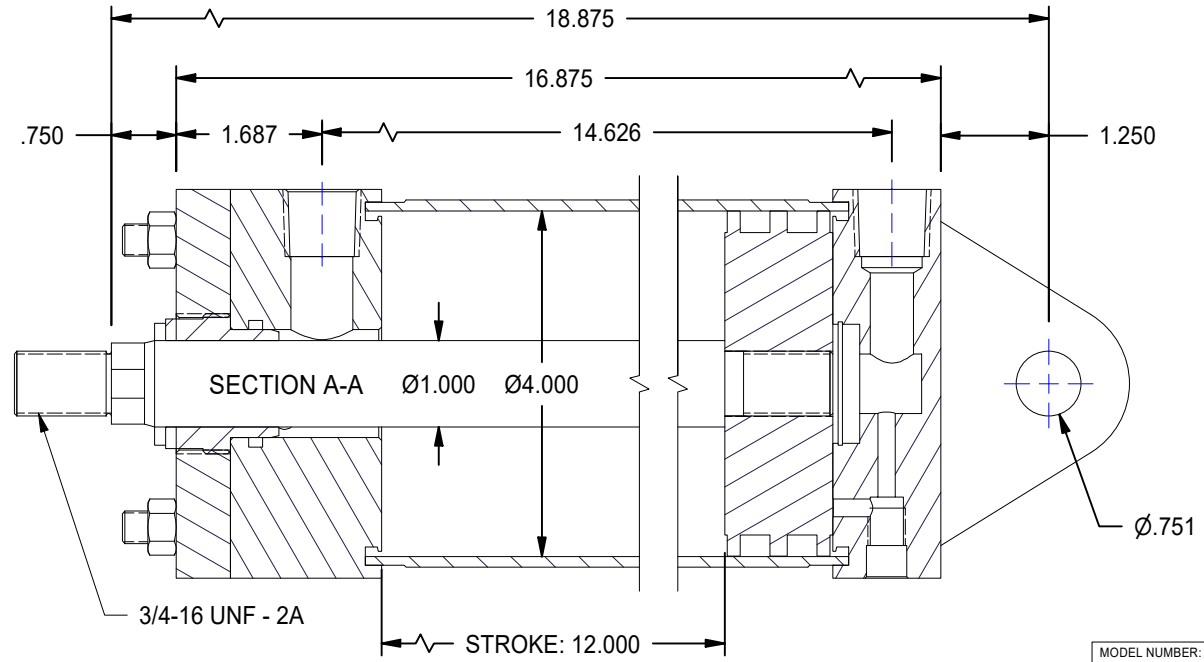

B

B

1

2

DATE	INTL	DESCRIPTION	REV

MODEL NUMBER:

PROJECT/CUSTOMER INFO:

DSGND: DATE: 2013-03-07

CAPACITY: 250 PSI

WEIGHT: 35.488 lbmass

SHEET SIZE: A SHEET: 1 OF 1 FILENAME: TRP4.00MP1LU14X12.00.idw

TITLE: TRP4.00MP1LU14X12.00

DRAWING No: REVISION:

701 MONTREAL STREET
THUNDER BAY, ON
P7E 3P-2
CANADA
TEL: 807-474-5337
FAX: 807-623-5692
www.titanworldwide.com